

S10 MT BLAST 2

SETUP SHEET

FRONT SUSPENSION

Shock position

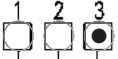

Upper arm position

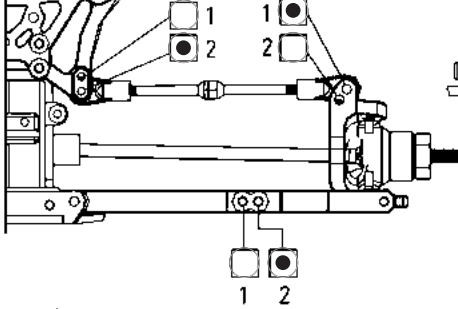

Caster angle
Standard: 10°
Option: 4°

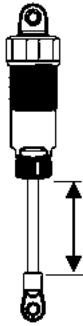
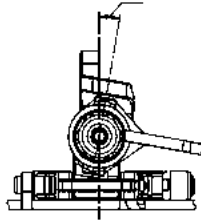

Front shock
Oil: LRP 30wt
Pistons: std
Spacer: 0mm
Springs: std

Toe angle

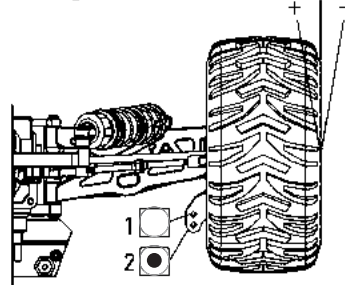

Front toe angle 0°
Notes _____
Rear toe angle +2.5°
Notes _____

Camber angle

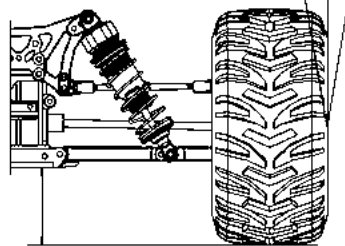

Camber front -2°
Notes _____
Camber rear -2°
Notes _____

Rideheight front 59mm
Rideheight rear 59mm

REAR SUSPENSION

Shock position

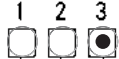

Upper arm position

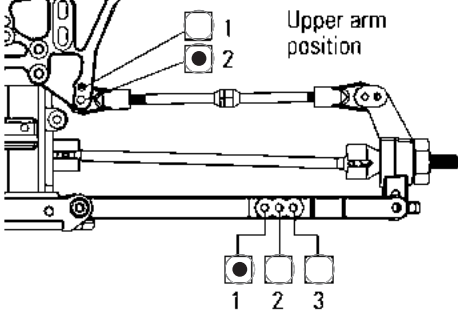

Wheelbase adjustment

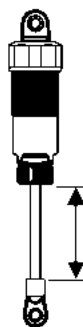
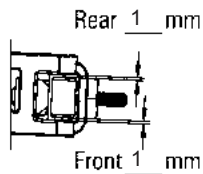

Rear shock
Oil: LRP 30wt
Pistons: std
Spacer: 4mm
Springs: std

Tire

Front _____ Rear _____
Type: std (#122270) Type: std (#122270)
Foam: _____ Foam: _____

Motor: _____ Battery: _____
Spur Gear: 77T ESC: _____
Pinion Gear: _____ Servo: LRP R-7103WP

Track conditions

Size: Open Med Tight
Traction: High Med Low
Surface: Smooth Med Bumpy

Diff Oil

Front: Grease
Rear: Grease

Comment

Basic Setup, LRP Team

Name: _____

Date: _____

Track: _____